

# INTERFEROMETER VI-DIRECT

Universal Interferometers for  
Quality Control

Instruments You Can Trust

**HS** MÖLLER-WEDEL  
OPTICAL

## Möller-Wedel Optical GmbH

# Optical Metrology “Made in Germany” for more than 40 countries worldwide

Möller-Wedel Optical GmbH, based in Wedel near Hamburg, Germany, is a globally active company that develops, manufactures and sells high-precision optical measuring systems for mechanical engineering, the automotive industry, the optical industry, the semiconductor industry, for film camera service, and for calibration and research laboratories.

For more than 50 years, the company’s optical measuring instruments have enjoyed an excellent reputation worldwide for their quality and durability.

Möller-Wedel Optical is certified according to DIN EN ISO 9001:2015. As the world market leader in the field of small angle metrology, Möller-Wedel Optical operates an EN ISO 17025:2018 accredited calibration laboratory for the dimensional quantity angle - angle standards.

The team of specialists from the fields of optics, optoelectronics, metrology, physics and precision engineering is constantly working on new innovative products and solutions for the demanding measurement tasks of its customers. From research and development to production, Möller-Wedel Optical combines the latest technologies with traditional skills. This ensures the highest quality and precision.

## Interferometer VI-direct Ideal for Quality Control and Manufacturing

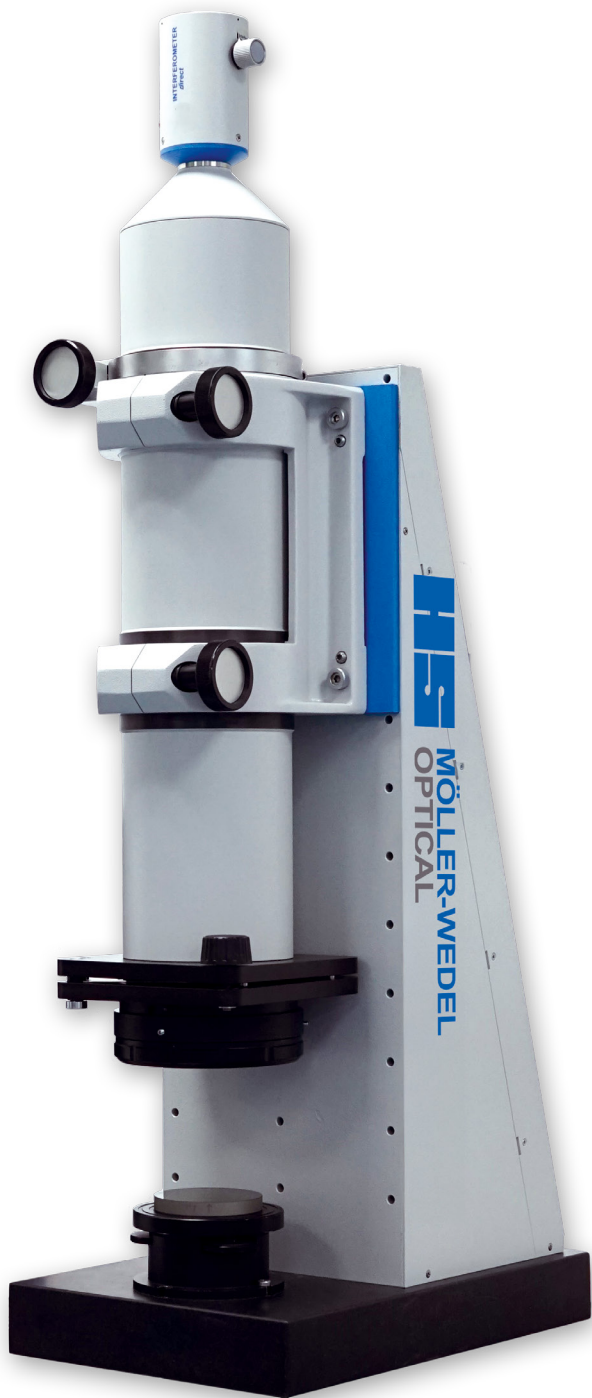

Interferometers are an indispensable measurement tool for the production and quality control of optical components and systems. Pleasingly, this opens up a wide range of applications: testing the flatness and sphericity of surfaces, radius measurements, and testing the optical effect of optical systems.

### SERIAL PROFILE

- Principle of operation: Fizeau interferometer
- Cost-effective and robust interferometer series
- Digital camera with high lateral resolution (3088 x 2076 pixels)
- Connect directly to computer using USB 3.0 port
- 4x digital enlargement, no optical zoom required
- Test diameter: approx. 3 - 100mm (depending on used lens tube)
- Can be used in a variety of positions, making it customizable and versatile for a range of customers
- Two different lasers ( $\lambda=632.8\text{nm}$ ) can be selected according to the specific requirements of each application area
- Comes with a wide range of optical and mechanical equipment
- Visual and software-driven evaluation with INTOMATIK-N / INTOMATIK-S / INTOMATIK-Live

## Schematic Diagram Structure of the Series

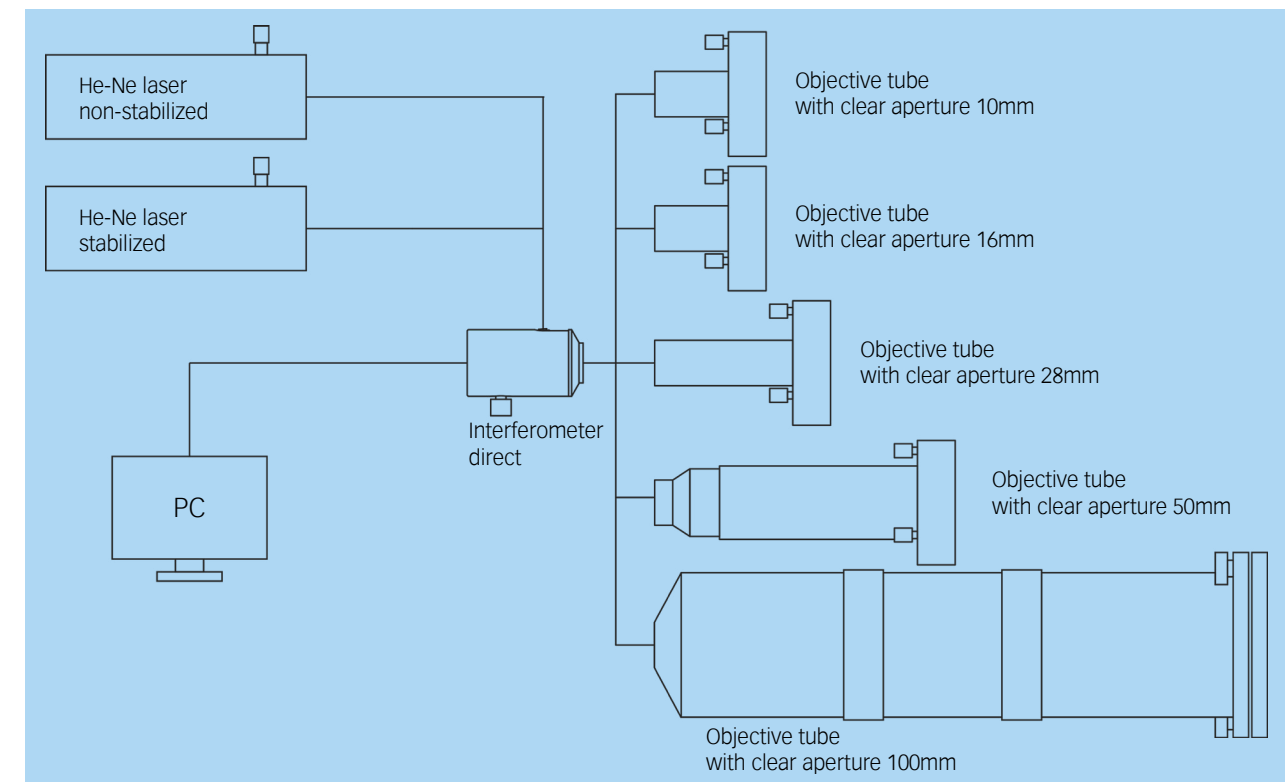

### Which laser suits my application?

He-Ne laser stabilized	He-Ne laser non-stabilized
Single-mode – optimized for a single resonant frequency	Multimode – 2-3 superimposed resonant frequencies
Long coherence length (up to 3,000mm)	Short coherence length (up to 50mm)
Suitable for any application	Main application: Flatness measurement of flat surfaces with short distances between test specimen and reference surface
Higher acquisition cost	Lower acquisition cost
Average laser run-in time	Short laser run-in time
Power supply via mains adapter	Power supply via cold power plug

# Measurement Variability Typical Applications in Practice

TESTABLE OBJECTS: MIRRORS, PRISMS, AND PLANE GLASSES

## Flatness Measurements of Surfaces

Measurement setup: reference plate, biaxial tilt device, test specimen holder (e.g. self-centering holder)

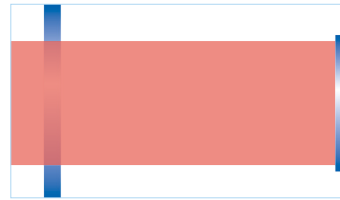

TESTABLE OBJECTS: TRANSPARENT WEDGES + PLANE PLATES, AFOCAL SYSTEMS, HOMOGENEITY MEASUREMENT

## Wavefront Determination and Wedge Angle Measurement on Plano Optical Components

Measurement setup: Two reference plates, one or two 2-axes adjustable mount, possibly test specimen holder (e.g. self-centering holder)

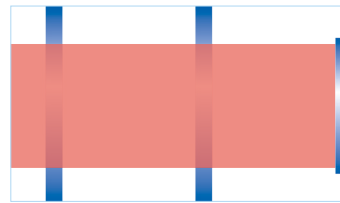

TESTABLE OBJECTS: LENSES, SPHERICAL SURFACES, GERMANIUM LENSES

## Lens and Mechanical Part Sphericity Measurement

Measurement setup: a Fizeau lens, 4-axes adjustable mount, sample holder (e.g. self-centering holder), radius measuring rail

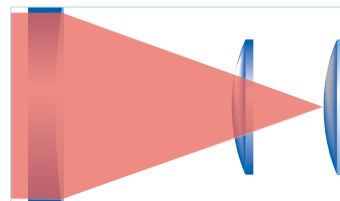

TESTABLE OBJECTS: LENSES, SPHERICAL SURFACES, GERMANIUM LENSES

## Radius Measurement on Lenses and Mechanical Parts

Measurement setup: a Fizeau lens, 4-axes adjustable mount, sample holder (e.g. self-centering holder), radius measuring rail

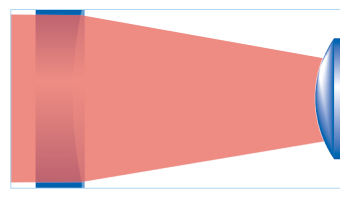

TESTABLE OBJECTS: EYEPIECES, ACHROMATS, PHOTO OBJECTIVES

## Wavefront Measurement of Lenses and Imaging Systems

Measurement setup: a Fizeau lens, 4-axes adjustable mount, sample holder (e.g. self-centering holder), radius measuring rail, reference plate

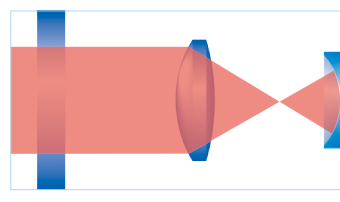

TESTABLE OBJECTS: GLASS PRISMS, MIRROR PRISMS, CUBE CORNERS

## Angle Measurement on 90° Prisms and Retro-reflector

Measurement setup: reference plate, 2-axes adjustable mount / tilt device, sample holder (e.g. self-centering holder)

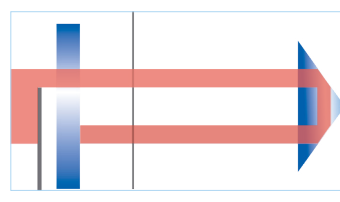

# Measurement Setup Scenarios of Typical Application

Thanks to the compact design, the interferometers are ideal for use in application specific workstations. The illustrations show some application examples for the VI-series interferometers.



MEASURING STATION FOR RAPID TESTING OF PLANOPTICAL COMPONENTS



MEASURING STATION FOR TESTING OF PLANE SURFACES IN INCIDENT LIGHT

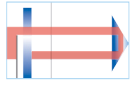

MEASURING STATION FOR RADIUS DETERMINATION AND TESTING OF PLANE AND SPHERICAL SURFACES IN INCIDENT LIGHT

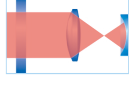
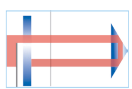
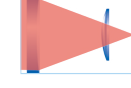
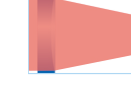

MEASURING STATION FOR THE DETERMINATION OF RADIUS AND WAVEFRONT DEFORMATION, TESTING OF PLANE AND SPHERICAL SURFACES

## Interferometer VI-direct with free aperture 10, 16 and 28mm

The VI-direct interferometers with a free aperture of 10, 16 or 28mm allow the testing of optics from 3 to 28mm in diameter. A He-Ne laser with a wavelength of 632.8nm is included in the scope of delivery.

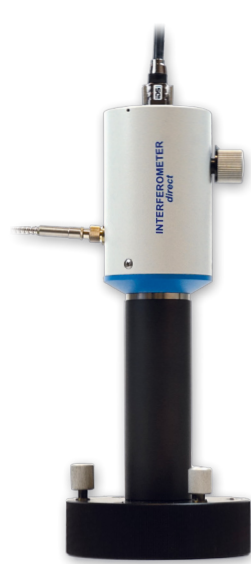

VISUAL STRUCTURE

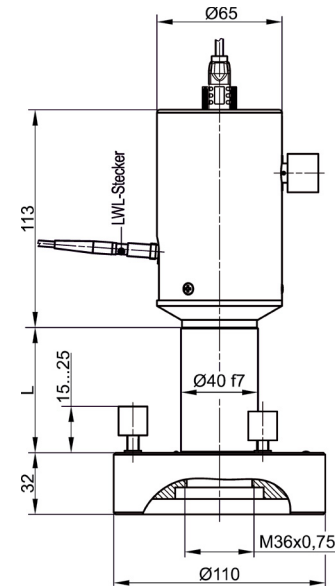

TECHNICAL STRUCTURE

Description	Test Field Ø [mm]	Laser	Art. No.
Interferometer VI-direct 10	3-10	He-Ne laser (none-stabilized)	244 306
Interferometer VI-direct SL 10	3-10	He-Ne laser (stabilized)	244 301
Interferometer VI-direct 16	4-16	He-Ne laser (none-stabilized)	244 307
Interferometer VI-direct SL 16	4-16	He-Ne laser (stabilized)	244 302
Interferometer VI-direct 28	7-28	He-Ne laser (none-stabilized)	244 308
Interferometer VI-direct SL 28	7-28	He-Ne laser (stabilized)	244 303

### Mechanical Equipment

Description	Art. No.
Height adjustable vertical stand D40 with tilt device	223 151
Height adjustable vertical stand D40 with XY- and tilt device	223 155
Height adjustable vertical stand D40 with XY-, tilt device, and phase shifter	223 159
Description	Art. No.
Vertical stand D40 with tilt device	223 108
Vertical stand D40 with tilt device and phase shifter	223 165
Description	Art. No.
Tripod stand D40	223 086



## Interferometer VI-direct with free aperture 50mm

The VI-direct interferometers with a free aperture of 50mm allow the testing of optics from 12 to 50mm in diameter. A He-Ne laser with a wavelength of 632.8nm is included in the scope of delivery.



VISUAL STRUCTURE

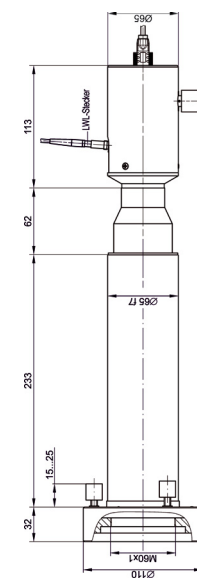

TECHNICAL STRUCTURE

Description	Test Field Ø [mm]	Laser	Art. No.
Interferometer VI-direct 50	12-50	He-Ne laser (none-stabilized)	244 309
Interferometer VI-direct SL 50	12-50	He-Ne laser (stabilized)	244 304

### Mechanical Equipment

Description	Art. No.
Height adjustable vertical stand D65 with tilt device	223 153
Height adjustable vertical stand D65 with XY- and tilt device	223 157
Height adjustable vertical stand D65 with XY-, tilt device, and phase shifter	223 161
Description	Art. No.
Vertical stand D65 with tilt device	223 107
Vertical stand D65 with tilt device and phase shifter	223 167
Description	Art. No.
Tripod stand D65	223 089



# Interferometer VI-direct with free aperture 100mm

The VI-direct interferometers with a free aperture of 100mm allow the testing of optics from 25 to 100mm in diameter. A He-Ne laser with a wavelength of 632.8nm is included in the scope of delivery.



VISUAL STRUCTURE

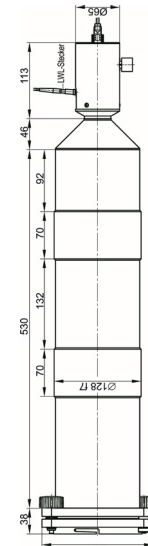

TECHNICAL STRUCTURE

Description	Test Field Ø [mm]	Laser	Art. No.
Interferometer VI-direct 100	25-100	He-Ne laser (none-stabilized)	244 310
Interferometer VI-direct SL 100	25-100	He-Ne laser (stabilized)	244 305

## Mechanical Equipment

Description	Art. No.
Height adjustable vertical stand D128 with tilt device	223 110
Height adjustable vertical stand D128 with XY- and tilt device	223 171
Height adjustable vertical stand D128 with XY-, tilt device, and phase shifter	223 173

Description	Art.-Nr.
Adjustable Holder D128	223 058

Description	Art.-Nr.
Clamp Fixtures D128	223 112

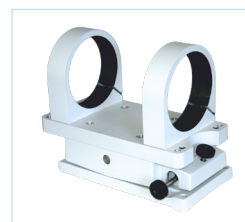
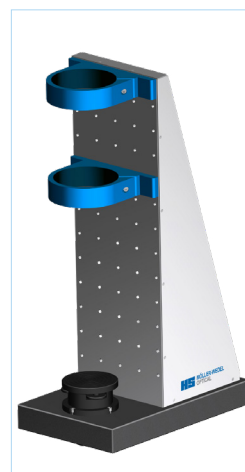

# Interferometer VI-direct PUL Measurement Station for Plane Surface In- spection

The VI-direct PUL flat surface interferometers allow rapid flatness testing of uncoated and mirrored plane surfaces from 7mm to 50mm in diameter, depending on the version selected. Thanks to its special design, the interferogram can be evaluated immediately after the specimen is placed on it, without the need for readjustment. These interferometers are available with or without phase shifters.



VISUAL STRUCTURE

### HARDWARE

The following components are included:

- Interferometer 28 PUL or 50 PUL
- Also available with phase shifter
- Supporting table with tilt mechanism
- Variety of aperture overlays
- Fiber coupled laser (632,8nm)

### SOFTWARE

- Für PUL S possible: Live Viewer Lite | INTOMATIK-Live | INTOMATIK-S
- Für PUL N necessary Software: INTOMATIK-N

Description	Test Field Ø [mm]	Art. No.
Interferometer VI-direct 28 PUL S (Without phase shifter)	7-28	244 936
Interferometer VI-direct 28 PUL N (With phase shifter)	7-28	244 937
Interferometer VI-direct 50 PUL S (Without phase shifter)	12-50	244 938
Interferometer VI-direct 50 PUL N (With phase shifter)	12-50	244 939

# Interferometer VI-direct Software Solutions

## INTOMATIK-N

### OVERVIEW

- Evaluation of 5 phase shifted interferograms
- Coordinates can be displayed in pixels, mm, or inches
- Manual or automatic calibration of the phase shifter unit selectable

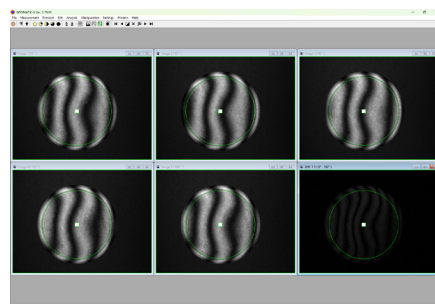

RECORDING VIEW

- Measurement of flat and spherical surface form deviation, absolute test measurements using the three-plate method, measuring 90° prisms as well as retroreflectors, and homogeneity measurements

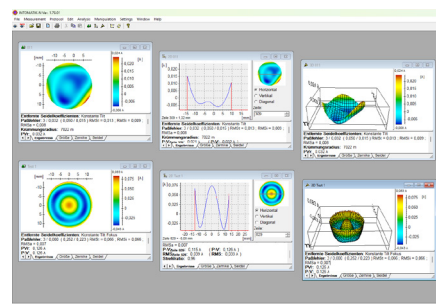

EVALUATION VIEW

- Live interferogram image permanently visible, coloured overload indicator in the live image
- Comprehensive masking function
- Histogram function

- Results displayed as contour, 3D, and 2D graphic
- Comprehensive options for further processing of the results

## INTOMATIK-S

- Evaluation of open interference fringes
- No phase shifter unit necessary
- Coordinates can be displayed in pixels, mm, or inches

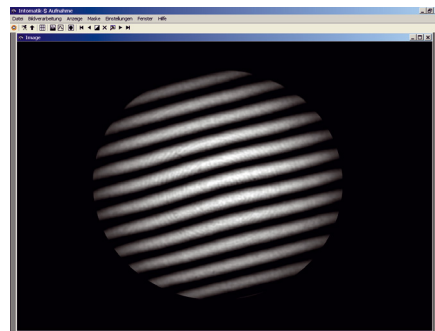

RECORDING VIEW

- The algebraic sign of the shape deviation cannot be automatically determined by fringe evaluation

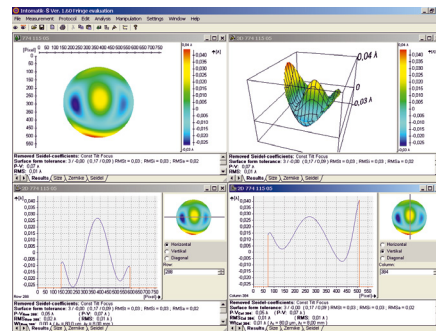

EVALUATION VIEW

- Live interferogram image permanently visible, colored overload indicator in the live image
- Comprehensive masking function
- Histogram function

- Results displayed as contour, 3D, and 2D graphic
- Comprehensive options for further editing of the result

## INTOMATIK-Live

### OVERVIEW

- Basic evaluation program for quick inspection in the production process
- No phase shifter unit necessary
- The algebraic sign of the shape deviation cannot be automatically determined by fringe evaluation
- Coordinates can be displayed in pixels, mm, or inches

### RECORDING AND EVALUATION VIEW

- Live interferogram image permanently visible
- Real-time interferogram evaluation
- View results as a contour graphic

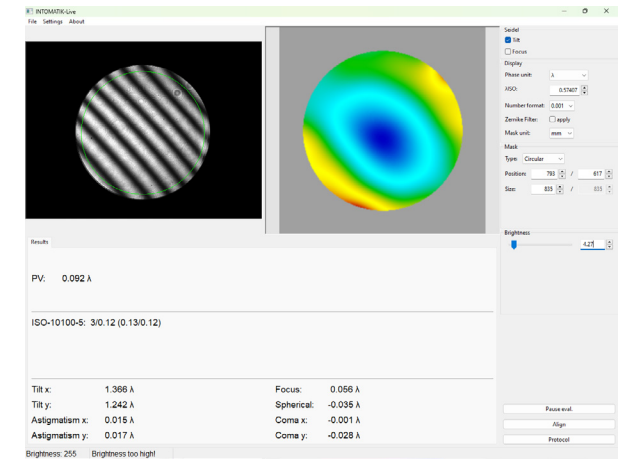

# Software Solutions An Overview

INTOMATIK-N	INTOMATIK-S	INTOMATIK-Live
Evaluation of 5 phase-shifted interferograms	Single image evaluation	Live interferogram image
Precision $\lambda/40$	Precision $\lambda/20$	Precision $\lambda/20$
Phase shifter unit necessary, evaluation of phase-shifted interferograms	No phase shifter unit necessary, Evaluation of open interference fringes	No phase shifter unit necessary, Evaluation of open interference fringes
Phase analysis with algebraic sign	Fringe evaluation without algebraic sign	Fringe evaluation without algebraic sign
Evaluation range can be set both manually and automatically	Evaluation range must be specified manually	Evaluation range must be specified manually
Measurement sensitive to vibration	Measurement less sensitive to vibration	Measurement less sensitive to vibration
Possibility of measurement of the form deviation beyond flat and spherical surfaces	Measurement of form deviations only possible on flat and spherical surfaces	Measurement of form deviations only possible on flat and spherical surfaces
Higher acquisition cost	Average acquisition cost	Low acquisition cost
Advanced analysis and display	Advanced analysis and display	Basic evaluation
Results displayed as contour, 3D, and 2D graphic	Results displayed as contour, 3D, and 2D graphic	View results as contour graphic
Operating system Windows 11		
Integrated digital zoom		
Coordinates can be displayed in pixels, mm, or inches		
Export of results in *.opd format or as raw data for further processing, storage of intensity images in *.bmp format, and protocol generation in *.rtf format	Export of results in *.opd format or as raw data for further processing, storage of intensity images in *.bmp format, and protocol generation in *.rtf format	Protocol generation in *.pdf format

# Focusing on Precision

## An Overview of Reference Optics and Interferometers

### Reference Optics

#### REFERENCE PLATE

- There are differences in reflection between mirrored and non-mirrored test specimens which require different reference plates
- An attenuation filter for mirrored test specimen is always necessary
- On request, we will be pleased to provide you with information about possible attenuation filters, as well as reference plates with a combined attenuation filter

Measurement setups	Description	Art. no.
Free aperture 10–28mm	Reference plate D16; $\lambda/30$ p-v	244 350
Free aperture 10–28mm	Reference plate D28; $\lambda/30$ p-v	244 351
Free aperture 50mm	Reference plate D50; $\lambda/30$ p-v	244 353
Free aperture 100mm	Reference plate D100; $\lambda/20$ p-v	244 475



#### FIZEAU OBJECTIVES

Interested in Fizeau objectives?  
Further information is available on request.

### Technical Data

Interferometer	Test specimen	Laser	Dimension [mm]	Weight* [kg]	Art. No.
VI-direct 10	3-10	He-Ne laser (none-stabilized)	Ø110x254	1,5	244 306
VI-direct SL 10	3-10	He-Ne laser (stabilized)	Ø110x254	1,5	244 301
VI-direct 16	4-16	He-Ne laser (none-stabilized)	Ø110x254	1,5	244 307
VI-direct SL 16	4-16	He-Ne laser (stabilized)	Ø110x254	1,5	244 302
VI-direct 28	7-28	He-Ne laser (none-stabilized)	Ø110x306	1,7	244 308
VI-direct SL 28	7-28	He-Ne laser (stabilized)	Ø110x306	1,7	244 303
VI-direct 50	12-50	He-Ne laser (none-stabilized)	Ø110x484	3,0	244 309
VI-direct SL 50	12-50	He-Ne laser (stabilized)	Ø110x484	3,0	244 304
VI-direct 100	25-100	He-Ne laser (none-stabilized)	□164x770	9,7	244 310
VI-direct SL 100	25-100	He-Ne laser (stabilized)	□164x770	9,7	244 305
VI-direct 28 PUL S	7-28	He-Ne laser (none-stabilized)	Ø110x306	6,5	244 936
VI-direct 28 PUL N	7-28	He-Ne laser (none-stabilized)	Ø110x306	7,7	244 937
VI-direct 50 PUL S	12-50	He-Ne laser (none-stabilized)	Ø110x484	7,8	244 938
VI-direct 50 PUL N	12-50	He-Ne laser (none-stabilized)	Ø110x484	9,0	244 939

#### MEASURING ACCURACY

Visual analysis  $\lambda/10$  p-v  
Software analysis up to  $\lambda/40$  p-v

\*Attention: Dimensions and weights without laser.



**Möller-Wedel Optical GmbH**

Rosengarten 10

22880 Wedel

Germany

Phone +49 41 103 937 76 10

[info@moeller-wedel-optical.com](mailto:info@moeller-wedel-optical.com)

<https://www.moeller-wedel-optical.com>