

ELCOMAT[®] 5000

Electronic Autocollimator

Möller-Wedel Optical GmbH

Your Specialist for High-Precision Optical Measurement Systems

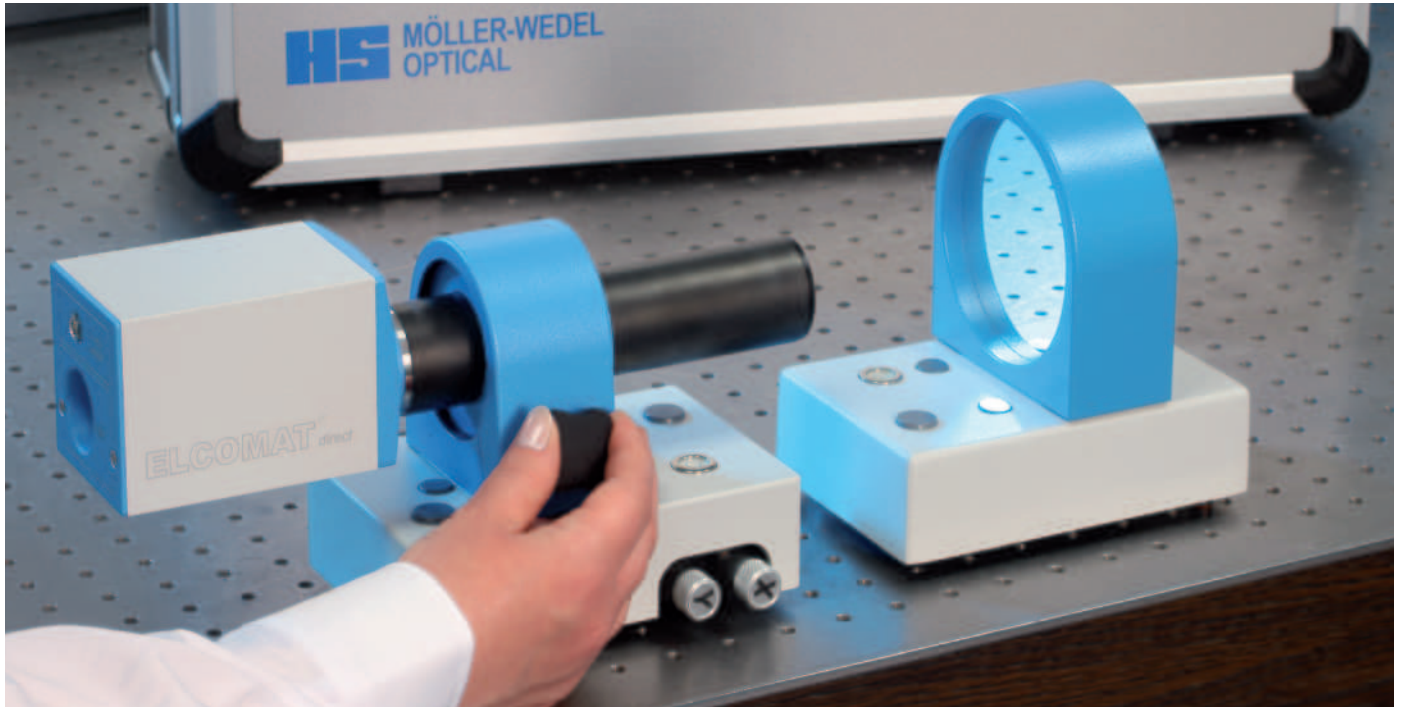

Optical Metrology "Made in Germany" for more than 40 countries worldwide

Möller-Wedel Optical GmbH, based in Wedel near Hamburg, Germany, is a globally active company that develops, manufactures and sells high-precision optical measuring systems for mechanical engineering, the automotive industry, the optical industry, the semiconductor industry, for film camera service and for calibration and research laboratories.

For more than 50 years, the company's optical measuring instruments have enjoyed an excellent reputation worldwide for their quality and durability.

Möller-Wedel Optical is certified according to DIN EN ISO 9001:2015. As the world market leader in the field of small angle metrology, Möller-Wedel Optical operates an EN ISO 17025:2018 accredited calibration laboratory for the dimensional quantity angle - angle standards.

The team of specialists from the fields of optics, optoelectronics, metrology, physics and precision engineering is constantly working on new innovative products and solutions for the demanding measurement tasks of its customers. From research and development to production, Möller-Wedel Optical combines the latest technologies with traditional skills. This ensures the highest quality and precision.

Möller-Wedel Optical GmbH

Our ELCOMAT® Product Line

Autocollimators are optical measuring instruments that measure the smallest changes in the angular position of optical reflectors. They are mainly used for the following measuring tasks: measurement of smallest angles, ultra-precise angle adjustment and angle calibration, quality assurance of machine tools and their components, assembly automation, angular position monitoring.



ELCOMAT® 5000

Compared to its predecessor, the ELCOMAT®3000, the ELCOMAT®5000 not only has a larger measuring range and a better signal-to-noise ratio due to the direct signal processing in the measuring head, but also a 10 times higher measuring frequency. More information can be found on the following pages.

ELCOMAT® vario N

The ELCOMAT®vario N autocollimators are characterized by direct signal digitization in the sensor head, a high degree of user-friendliness and an extended range of functions of the 5000 display unit. They are available with objective tubes of different focal lengths. More information about this product is available at www.moeller-wedel-optical.com.

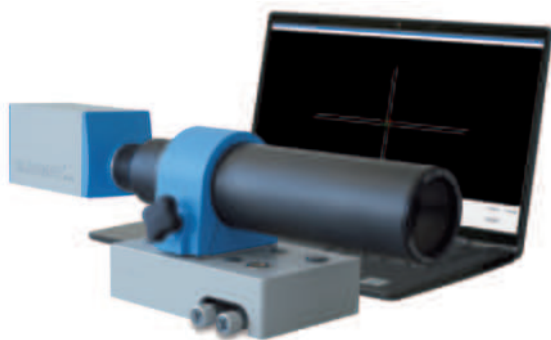
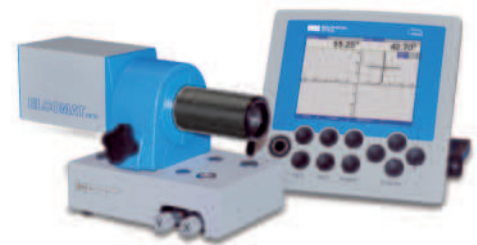

ELCOMAT® direct N

Each ELCOMAT®direct N consists of an autocollimation sensor and the ELCOdirect software, which can be used with Microsoft® Windows and a current PC or laptop. More information about this product is available at www.moeller-wedel-optical.com.

ELCOMAT® HR

The ELCOMAT®HR is a measuring instrument for applications with highest accuracy requirements. An ultra-stable mechano-optical design and specially developed evaluation and calibration algorithms are the basis for the excellent accuracy. This makes the ELCOMAT®HR an ideal reference instrument for national calibration institutes. More information about this product is available at www.moeller-wedel-optical.com.



ELCOMAT® 5000 Electronic Autocollimator

Autocollimators are optical measuring instruments that can measure the smallest deviations in the angular position change of optical reflectors. With electronic autocollimators, the autocollimation image is detected using CCD lines or a camera.

Electronic autocollimators are primarily used for the following measuring tasks:

- Measurement of smallest angular deviations
- Ultra-precise angle adjustment and calibration
- Quality control of machine tools and its components
- Assembly automation
- Angular position monitoring

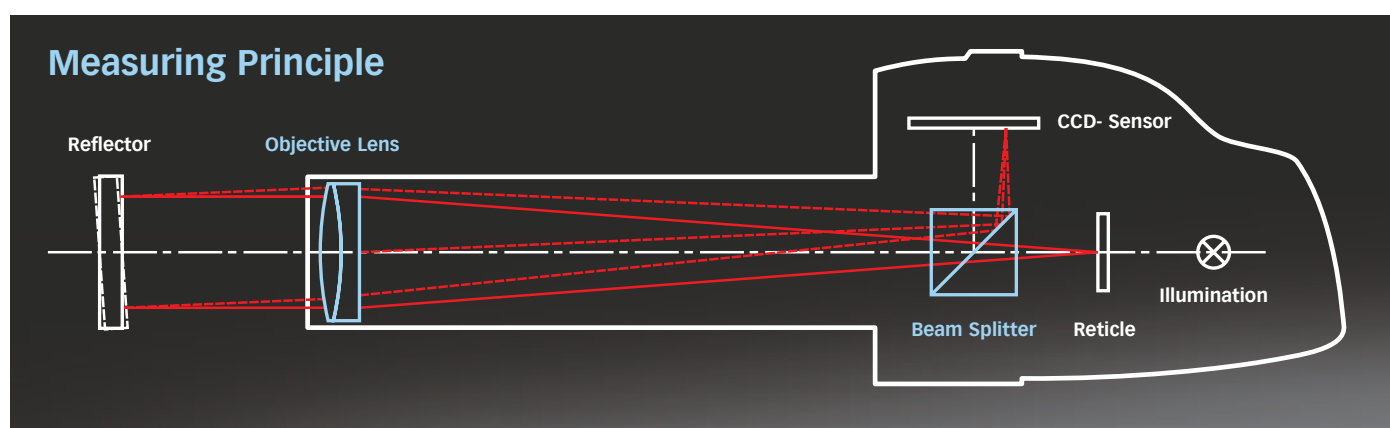
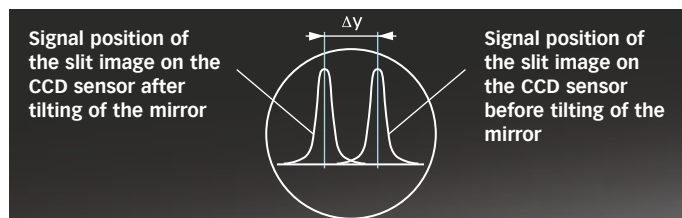

Typical Applications of the Autocollimator

Machine Tool Industry

- Measurement of the straightness of machine beds and guideways
- Measurement of position uncertainty of rotary and indexing tables
- Measurement of flatness of granite tables, measuring and leveling plates
- Measurement of parallelism of guideways
- Measurement of the squareness of 90° stone angle standard, guideways etc.

Optical, Laser and Semiconductor Industry

- Adjustment of reflectors
- Angular position monitoring

Calibration Institutes

- Calibration of autocollimators and polygon mirrors

Research Facilities

- Measurement of smallest angle deviations
- Long-term analyses of mechanical alignment units
- Adjustment of mirrors in optical set-ups
- Use in education

Measuring Range and Measuring Distance

The measuring range of any autocollimator decreases as the measuring distance increases. The measuring accuracy of autocollimation telescopes is independent of the distance under negation of environmental influences. With the autocollimators of the ELCOMAT® product line the measuring range is constant up to a certain measuring distance and then decreases as the distance between the autocollimator and the mirror

increases. The typical measuring range at different distances is listed in the technical specifications of the ELCOMAT® 5000.

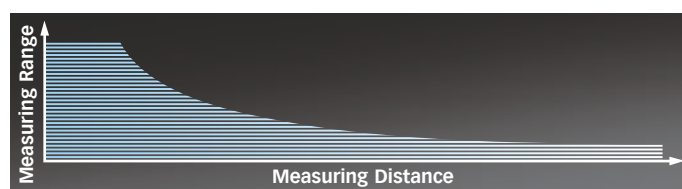

Components of the ELCOMAT® 5000

Autocollimation Sensor

In the autocollimation sensor, the reticle pattern reflected by an optical mirror is imaged on corresponding CCD sensors, digitized and their position change is evaluated. The direct digital signal processing in the sensor head guarantees an excellent signal-to-noise ratio. Compared to the ELCOMAT® 3000, the optical-electronic design allows for a 10-fold higher measurement frequency and significantly increases the dynamic range (measurement range/measurement uncertainty). Additional internal alignment sensors in the autocollimation sensor provide easy, fast and precise adjustment of the autocollimator.



Display Unit

The intelligent display module is essential for the operation of the autocollimator and functions as a digital control and output unit. The integrated software, designed for maximum user-friendliness, allows the autocollimator to operate fully independently of a PC/laptop. The extensive software functions are self-explanatory and easy to use even for unexperienced personnel.

A standard PC/laptop can also be connected to the display unit via the integrated USB interface. The standard interface protocol is compatible with the text protocol of the ELCOMAT® 3000/HR and the ELCOMAT® vario N series. Measurements at 250 Hz will use a separate interface protocol.



Transportation Box

The transport case (included in the scope of delivery) offers space for the following accessories:

In Scope of Delivery:

- Power supply
- IR remote control
- RS-232 cable
- USB cable
- Software INCOLINK

Optional:

- Adjustable Holder D65
- Laser Attachment
- Base mirror, complete
- Magnetic base
- Software ELCOWIN/RTM



ELCOMAT® 5000

Functions of the Display Unit

Selectable Display Modes/Functions

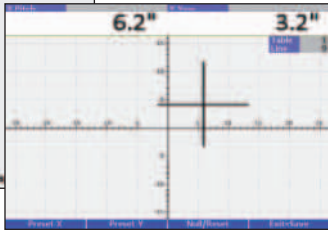
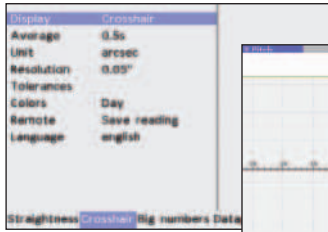

Graphical Display

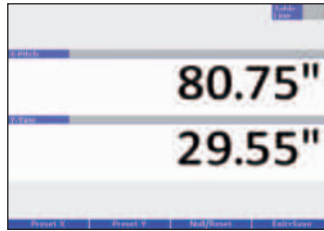

Numerical Display (large digits)

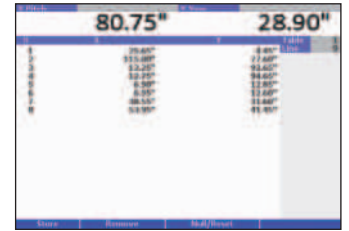

Numerical Display (table)

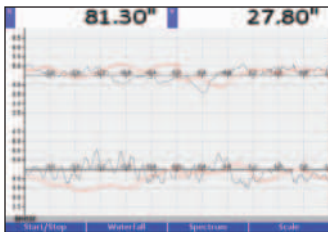

Trend of measuring values

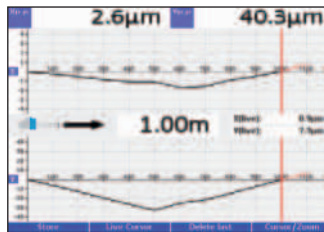

Straightness Measurement

In addition to the well-known graphical, numerical and tabular display, the display unit has additional functions such as time analysis of the measured values or a practical "on-the-fly" straightness measurement.

Angle Display in Different Angular Units of Measurement

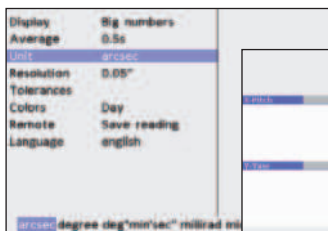

Seconds''

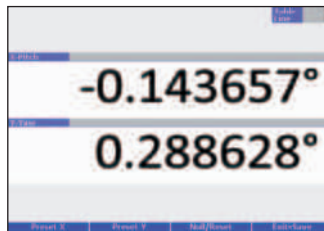

Degree°

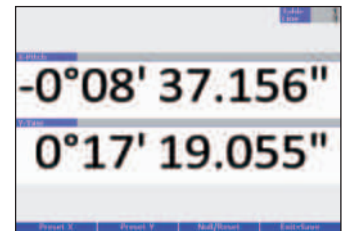

Degree° Min' Sec''

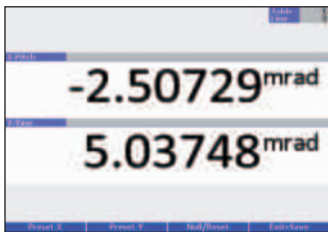

Milliradian

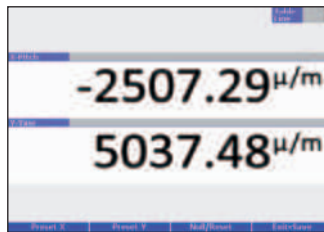

Micrometer per Meter

The display unit offers 5 selectable angular units.

Resolution of the Measured Data Display in 12 Steps

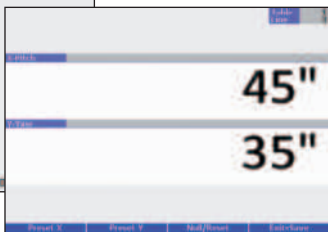
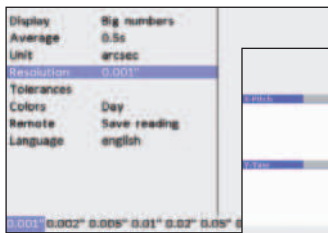

5''

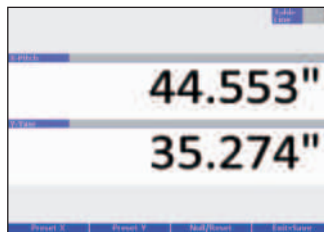

0.001''

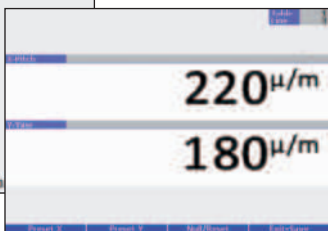
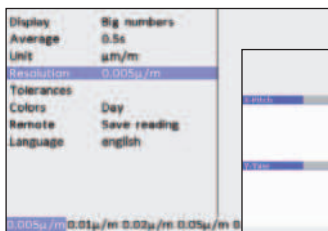

10 µm/m

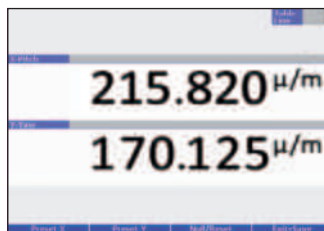

0.005 µm/m

12 resolution levels are available for different measurement requirements.

arcsec''	Degree°	µ/m
5	0.001	20
2	0.0005	10
1	0.0002	5
0.5	0.0001	2
0.2	0.00005	1
0.1	0.00002	0.5
0.05	0.00001	0.2
0.02	0.000005	0.1
0.01	0.000002	0.05
0.005	0.000001	0.02
0.002	0.0000005	0.01
0.001	0.0000002	0.005

Digital Zoom

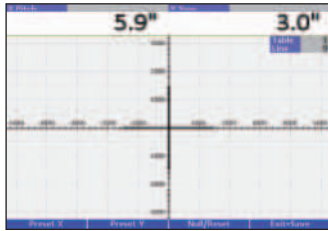

Display Area 5000" x 3000"
Interval 200"

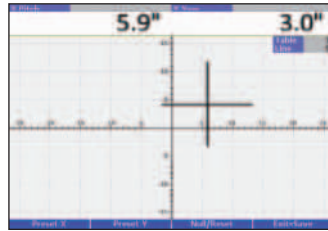

Display Area 25" x 15"
Interval 1"

Display Area arcsec"	Interval arcsec"
5000 x 3000	200
2500 x 1500	100
1250 x 750	50
500 x 300	20
250 x 150	10
125 x 75	5
50 x 30	2
25 x 15	1

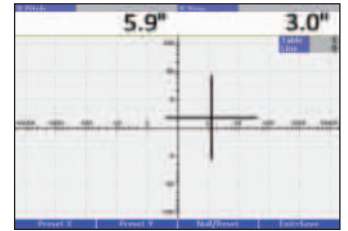

Logarithmic Scale

The display unit allows comfortable adjustment of the autocollimator or reflector by using 8 digital zoom levels or an additional display mode in logarithmic scale.

Tolerances

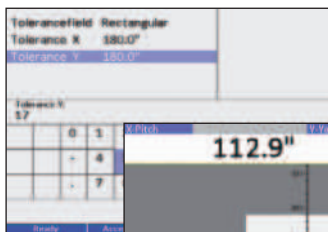

Input of tolerance limits and display of a rectangular tolerance field

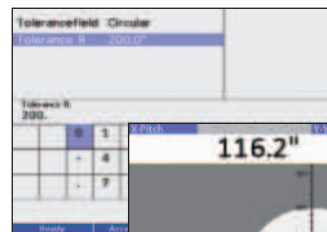
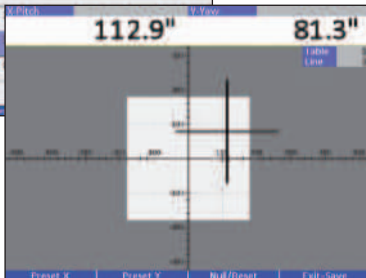

Input of tolerance limits and display of a circular tolerance field

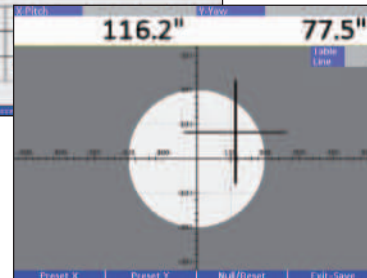

The graphical display of a rectangular or circular tolerance field allows a quick tolerance check. The size of the tolerance field is editable.

Averaging

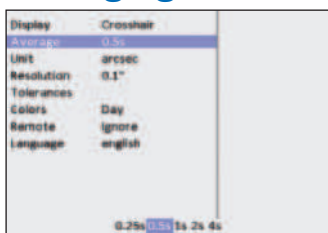

Setting the averaging time only influences the display of the measured values in the display unit. With a low time value, fast measurement or adjustment is possible. If the signal-to-noise ratio is low, less noisy measured values can be displayed due to a longer averaging time.

Time Diagram

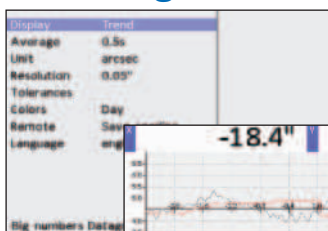

For the time analysis of the measured value characteristics the graphic representations are available as curve, spectrum or waterfall diagram. This allows a quantitative assessment of the stability, drift, frequency behavior etc. of the measured values.

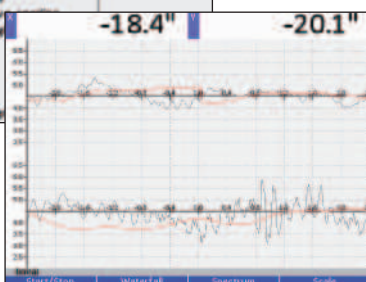

Curve

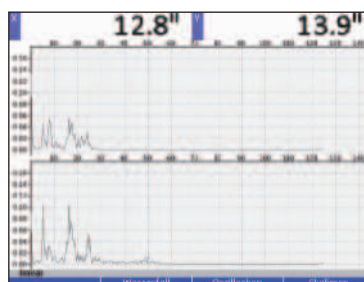

Spectrum

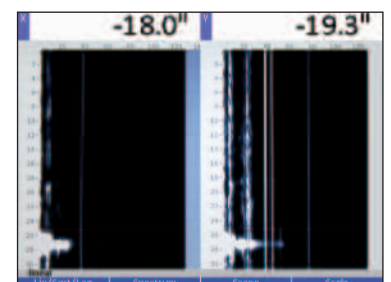

Waterfall Diagram

ELCOMAT® 5000

Functions of the Display Unit

Remote Control



This function defines the commands for the IR remote control. The following settings are possible:

- Save
- Reset
- Delete

Adjustment

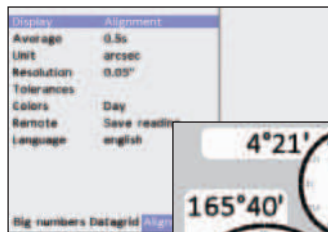

With this function, the measuring sensor can be aligned to the earth axis (pitch, yaw, roll) without any further aids. In addition, the measured environmental data temperature, humidity and air pressure are displayed on the monitor.

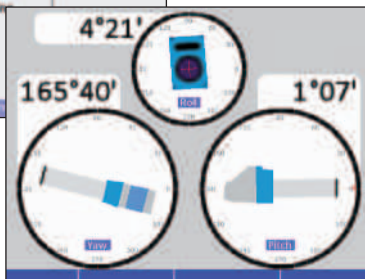

Language Selection

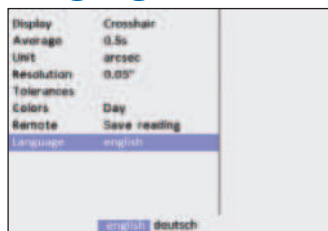

The display unit supports the following languages:

- German
- English

Color Selection

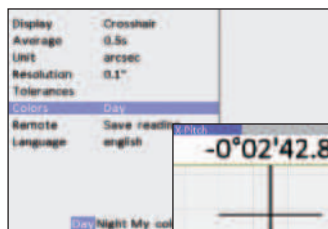

In addition to the well-known view (day mode), the view setting can be switched to night mode.

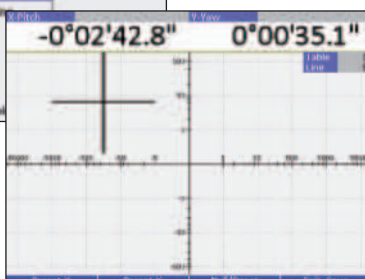

ELCOMAT® 5000

Principle of Straightness/Flatness Measurement

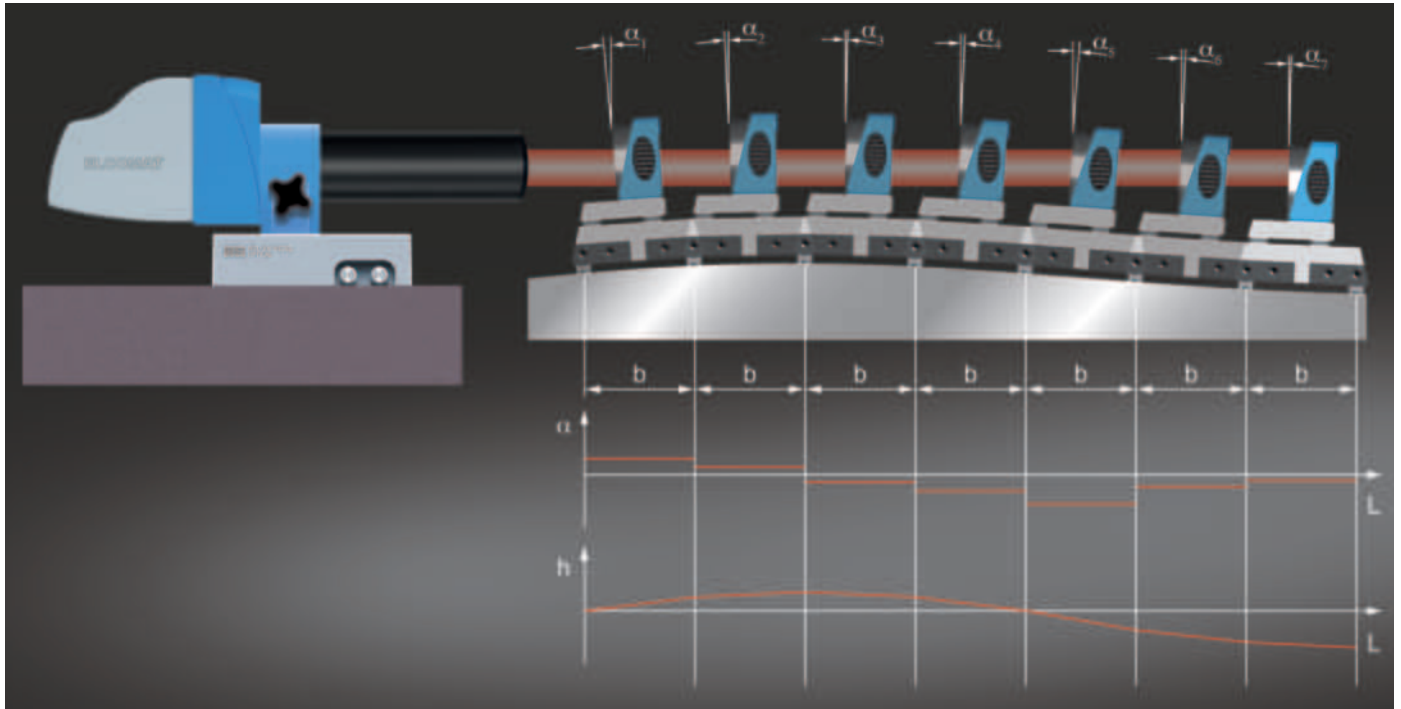

Principle:

To measure straightness, the autocollimator is placed on a reference position to the guideway and the corresponding mirror with base and stop bar are placed on the guideway. When the mirror is shifted, any deviation of the straightness (horizontal/vertical) of the guideway surface leads to a shift of the autocollimation image. To measure the lateral and height deviation of the guide, the mirror with base and stop bar is moved step by step by a corresponding base length (standard 50 or 100 mm) in the direction of measurement to determine the corresponding slope m ($m_{x,y} \approx \Delta\alpha_{x,y}$). The height or side deviation results from the product of the local slope m and the base length of the mirror b .

Function Straightness in Display Unit:

The special feature of the easy-to-use straightness measurement function in the display unit is that it displays the profile directly after the measured value has been recorded and is also able to calculate the effects of individual changes to certain measuring positions on the entire measuring path. This eliminates the need for time-consuming re-measurement of the entire measuring path and the operator can correct measuring points "on-the-fly" using the overwrite function. The cursor function can also be used to simulate the influence of changes on the curve profile, for example before scarring or straightening.

For more comprehensive evaluation, logging and protocol management the proven [ELCOWIN](#) software can be used.

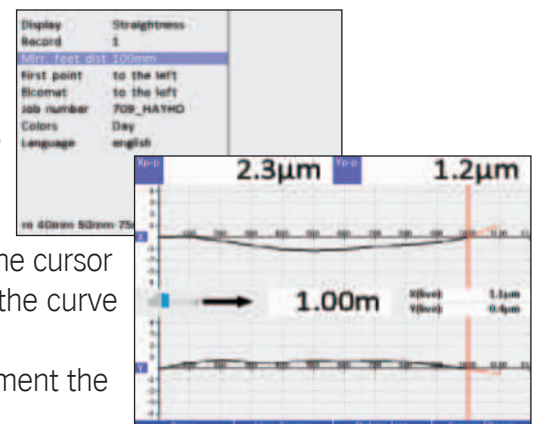

ELCOMAT® 5000

Typical applications

Typical applications for the ELCOMAT® product line are:

- Straightness, Parallelism, Tilt Angle measurement
- Flatness measurement
- Rotatory position uncertainty measurement
- Squareness measurement
- Wobble measurement, adjustment of reflectors
- Calibration of angle measuring instruments
- Calibration of reference standards

Straightness, Parallelism, Angle Tilting

Measurement of straightness, parallelism of guideways up to a length of 25 m and measurement of angular tilting of a slide or deformation of machine parts.

Recommended Accessories:

Art.No.:223 056, 223 082*, 223 271,
219 757, 221 015*, 221 028*,
219 736*

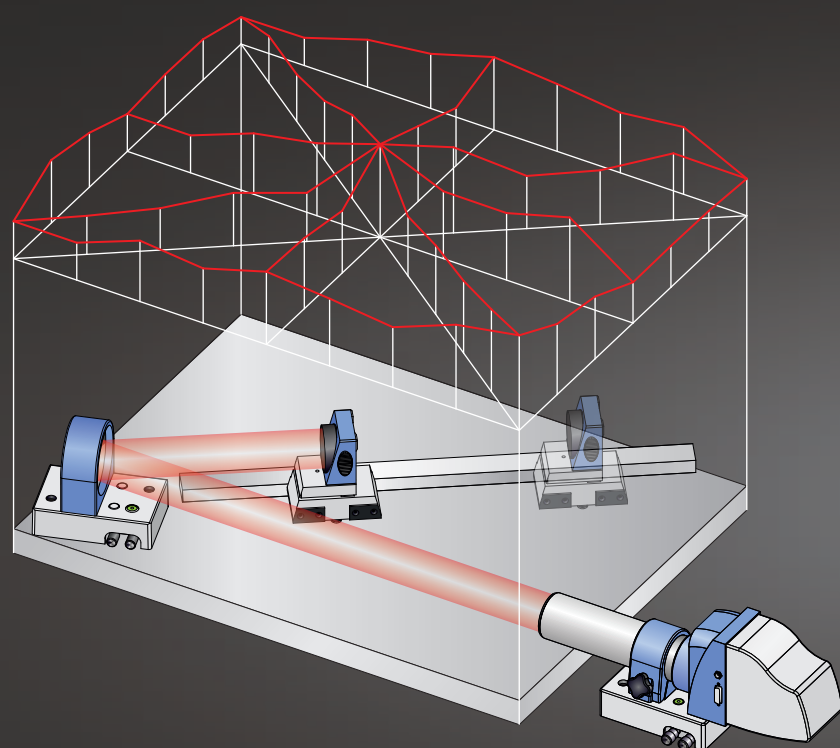
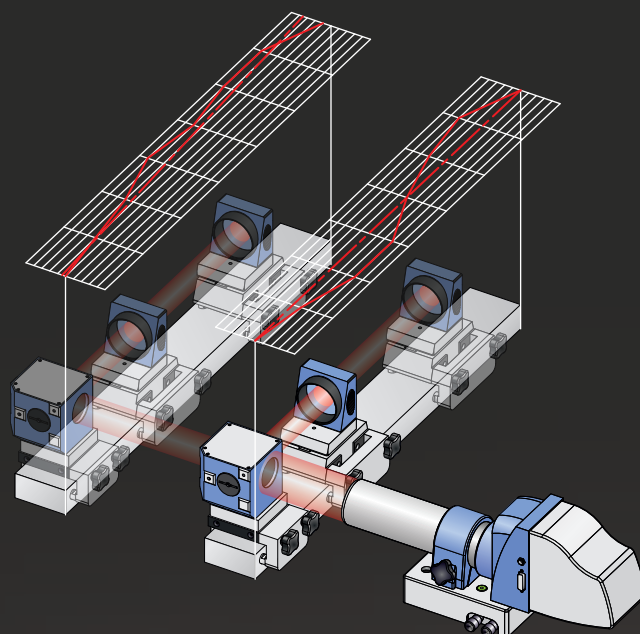

Flatness

Flatness measurement of large, flat surfaces, e.g. stone plates, leveling plates and optical tables.

Recommended Accessories:

Art.No.:223 056, 223 271, 219 757,
223 221*, 219 736*

Squareness

Measurement of the squareness from spindle axis to steady rest axis, from spindle stroke to machine bed and between guideways or of 90° stone-angle standards.

Recommended Accessories:

Art.Nr.: 223 056, 223 082*, 223 271,
219 757, 221 015, 221 028,
219 736*

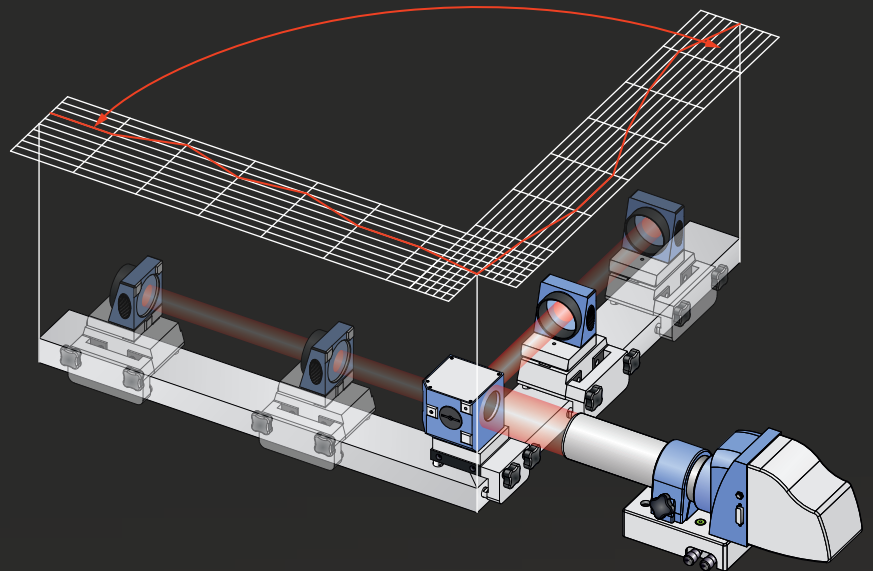

Position Uncertainty

Determination of the position uncertainty of index tables and rotary tables as well as the absolute measurement of polygon mirrors.

Recommended Accessories:

Art.Nr.: 223 056, 219 757, 205 313 or
205 307, 219 743*

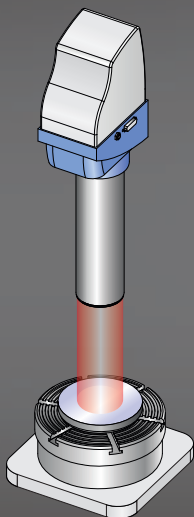
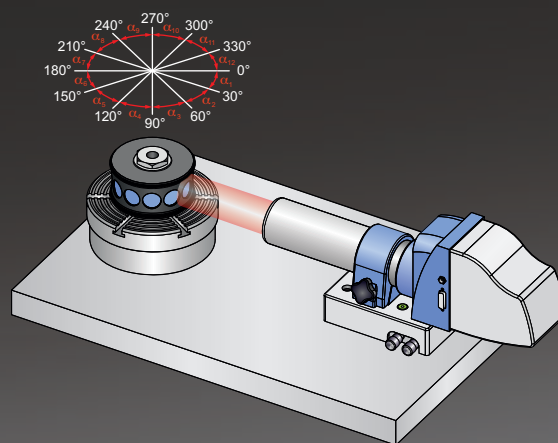

Wobble, Alignment, Angle measurement

Measurement of the wobble of bearings and rotary tables in reflection as well as wedge angle measurement in transmission against a mirror and alignment of optical components (e.g. mirrors), etc.

* Optional accessories depending on the respective measuring task

ELCOMAT® 5000

Optional accessories

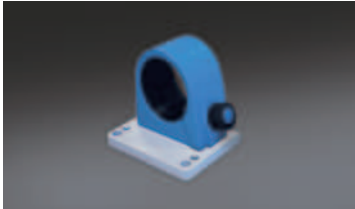

Clamp Fixture

For integration of the ELCOMAT® 5000 into existing set-ups
 Height of optical axis: 62 mm
 Mounting: 4 x M6 screws

Description	Art. No.
Clamp fixture D65	223 037

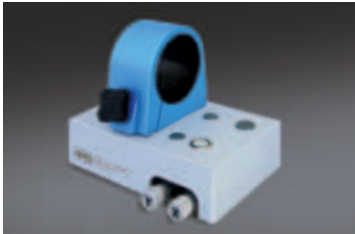

Adjustable Holder (±2°)

For mounting of the ELCOMAT® 5000 and for mounting on a tripod (Art.-No. 223 082)
 Adjustment range (x,y): ±2°
 Height of optical axis: 100 mm

Description	Art. No.
Adjustable holder D65	223 056

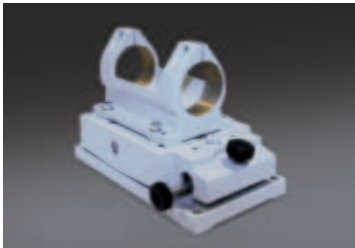

Adjustable Holder (±4°)

For mounting of the ELCOMAT® 5000 and for mounting on a tripod (Art.-No. 223 081)
 Adjustment range (x,y): ±4°
 Height of optical axis: 132 mm

Description	Art. No.
Adjustable holder with clamp fixture, double-sided D65	223 024



Tripod

Enables flexible use and quick change of measuring position due to short set-up and dismantling times
 Height: min. 630 mm, max. 1320 mm

Description	Art. No.
Tripod for adjustable holder 223 024	223 081
Tripod for adjustable holder 223 056	223 082

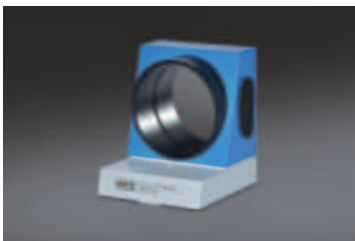

Mirror in Mount

Ideal for measuring straightness, squareness, parallelism and flatness
 Height of optical axis: 55 mm

Description	Art. No.
Mirror in mount, one-sided	223 260
Mirror in mount, double-sided	223 262



Base with Stop Bar

For the mounting of the mirrors in mount (Art. No. 223 260, 223 262), base length of 50 or 100 mm as well as precise guidance through removable stop bar
 Height of optical axis: 100 mm (incl. mirror)

Description	Art. No.
Base 100	223 264
Stop bar for base 100	223 269
Base mirror, complete (223 262 + 223 264 + 223 269)	223 271

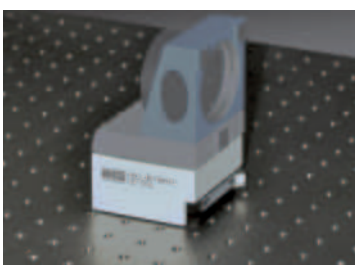

Magnetic Base

For mounting mirrors in mounts to any magnetic surfaces
 Height of optical axis: 100 mm (incl. mirror)

Description	Art. No.
Magnetic base for mirror additionally required:	223 282
Mirror in mount, one-sided or	223 260
Mirror in mount, double-sided	223 262

Description	Art. No.
Mirror D100, adjustable, double-sided	223 221

Mirror D100, adjustable

For use as auxiliary or turning mirror
Adjustment range $\pm 2^\circ$ in both axes
Height of optical axis: approx. 100 mm

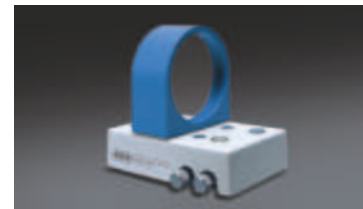

Description	Art. No.
Laser Attachment D65	219 757

Laser Attachment

For quick and easy alignment of the ELCOMAT® 5000 to a target reflector

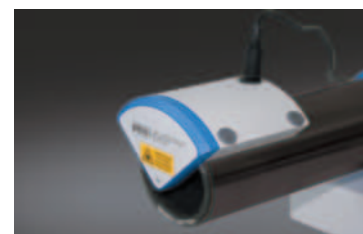

Description	Art. No.
Pentaprism 2" in mount	221 015
Pentaprism 2" with wedge in mount	221 016

Pentaprism in Mount

Extension for measurement of squareness and parallelism

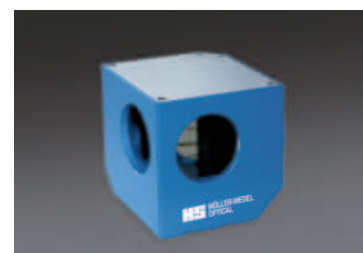

Description	Art. No.
Base for Pentaprism with stop bar	221 028

Base for Pentaprism

For mounting of the pentaprism (Art. No. 221 015, 221 016) with removable stop bar for precise positioning
Height of optical axis: 100 mm

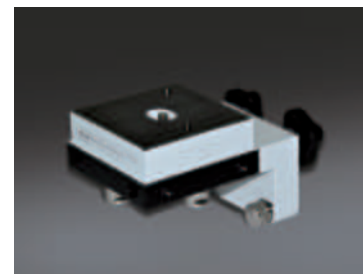

Description	Art. No.
Holder D65 for Pentaprism	221 023

Holder for Pentaprism

For mounting the pentaprism (Art. No. 221 015, 221 016) to the objective tube D65 of ELCOMAT® 5000 for measurement of squareness

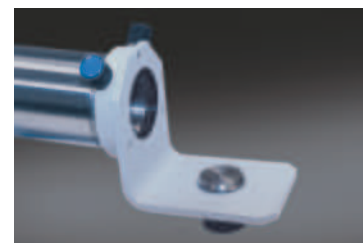

Description	Art. No.
Polygon Mirror 12 Surfaces 2"	205 313
Polygon Mirror 8 Surfaces 2"	205 307

Polygon Mirror

Angular measuring standard for the measurement of the rotatory position uncertainty of index or rotary tables

Mirror: \varnothing 38 mm (8 surfaces)
 \varnothing 25 mm (12 surfaces)

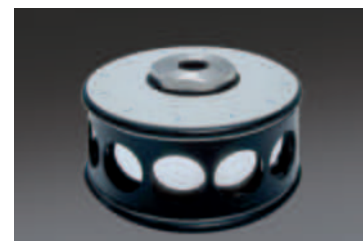

Description	Art. No.
Autocollimator Test-Wedge	223 244

Autocollimator Test-Wedge

Autocollimator test-wedge for quick testing of autocollimators.

The test-wedge is certified and allows on-site testing of angular accuracy.

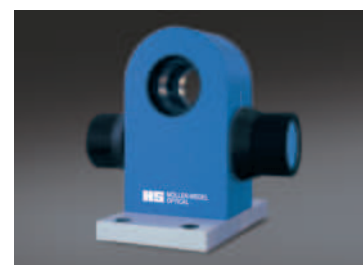

ELCOMAT® 5000 Software

INCOLINK

Software interface for transfer of measurement data from ELCOMAT® 5000 to computer

- Time-controlled recording of measured values
- Simple integration of the measured values via the clipboard into the customer's own software (e.g. Excel®).

Note: Runs under Windows®.

The INCOLINK software is always included in the scope of delivery of the ELCOMAT® 5000.

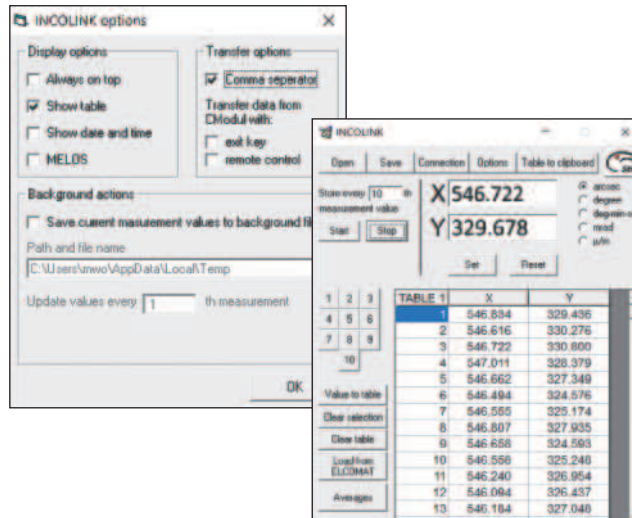

Description	Comment	Art.-No.
INCOLINK	In scope of delivery	219 739

ELCOWIN

ELCOWIN software for evaluation of straightness, squareness, parallelism and flatness of guideways and measuring plates and tables

- Automatic transfer of the ELCOMAT® 5000 measurement data to the software
- Simultaneous acquisition of the measured values of both measuring axes (horizontal/vertical)
- Optional: manual data input

Note: Runs under Windows®.

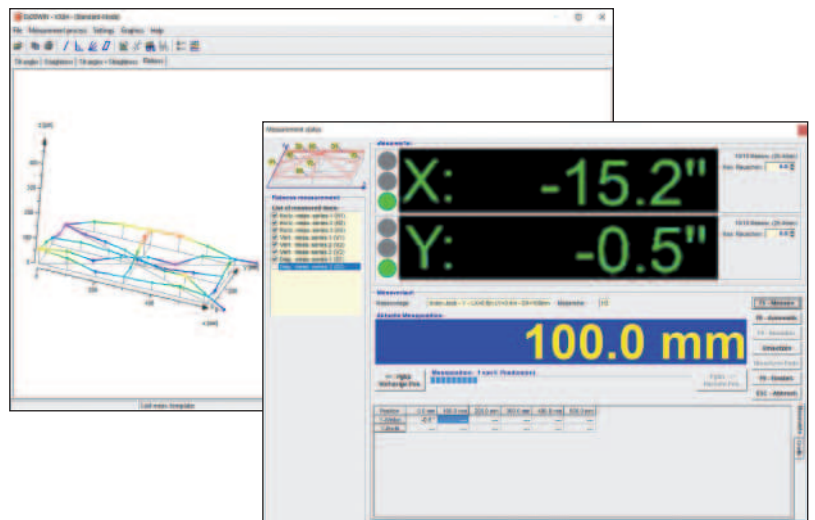

Description	Comment	Art.-No.
ELCOWIN	Language English	219 736

RTM

Software RTM for determination of position uncertainty/positioning accuracy of rotary tables/index tables according to VDI/DGQ 3441, VDI 2617, ISO 230-2

- Consideration of the angle errors of the angle standards used (polygon mirrors) in the calculation of the division positioning uncertainty error

Note: Runs under Windows®



Description	Comment	Art.-No.
RTM	Language English	219 743

ELCOMAT® 5000

Technical Data

Art.-No.	229 937
Accuracy	±0.1 arcsec over every 20 arcsec range (corresponds to ±0,5 µm/m) ±0.25 arcsec over total range (corresponds to ±1,2 µm/m)
Reproducibility	0.05 arcsec (corresponds to ±0,24 µm/m)
Resolution	0.001 to 10 arcsec; selectable, additional logarithmic scaling
Number of measuring axes	2
Possible measuring frequency	25 Hz / 250 Hz
Measuring range, X x Y	1.5 m 3000 x 3000 arcsec 2.5 m 2000 x 2000 arcsec 5.0 m 1000 x 1000 arcsec 10.0 m 500 x 500 arcsec 15.0 m 330 x 330 arcsec 20.0 m 250 x 250 arcsec
Max. measuring distance	25 m
Min. reflector diameter	∅ 5 mm mirrored (R>85%) ∅ 6 mm uncoated (R=4%)
Focal length	300 mm
Free aperture	50 mm
LED wavelength	635 - 640 nm
Tube diameter	∅ 65 f7 mm
Height of optical axis	100 mm (in adjustable holder 223 056) 62 mm (in clamp fixture 223 037)
Computer interface	RS-232 / USB
Mains voltage	90...250 V / 50...60 Hz
Weight	4.0 kg autocollimation sensor 0.7 kg display unit
Scope of delivery	autocollimation sensor, display unit, power supply, IR remote control, RS-232* and USB cable, INCOLINK software, transportation box

* Can be used in conjunction with an adapter to connect to the Ethernet interface.

ELCOMAT® is a registered Union Trade Mark (EUTM 018002083), Trade Mark in CN (Int. Reg. No. 1476462), US Trade Mark (6,010,398), Trade Mark in JP (1476462).

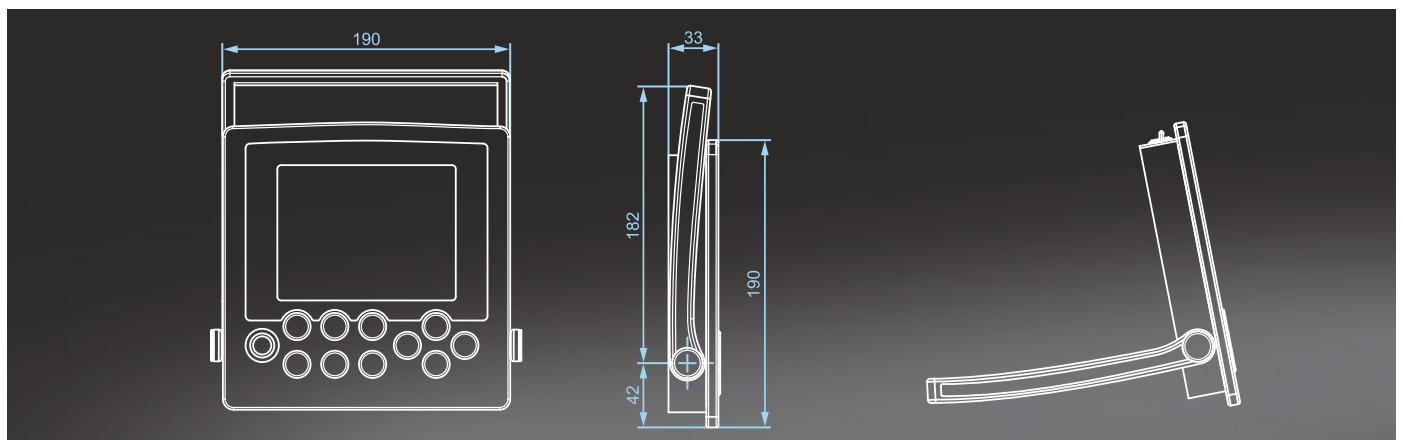
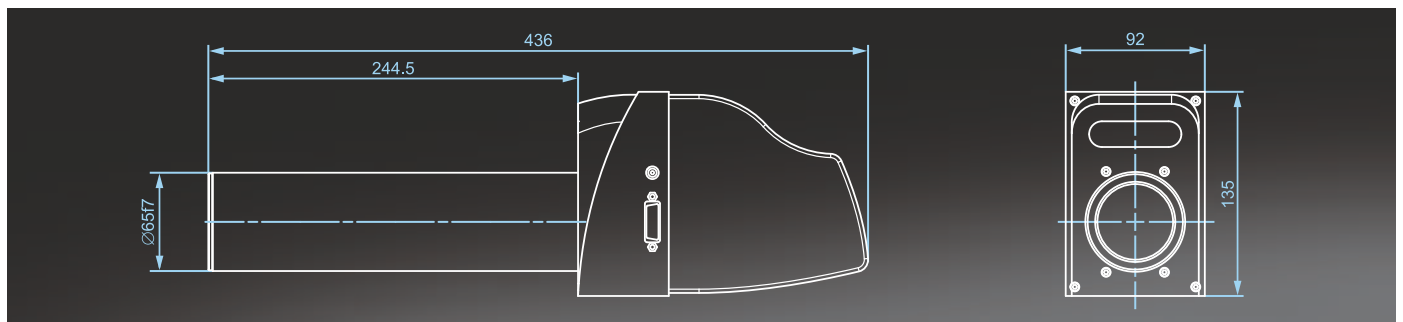

Möller-Wedel Optical GmbH

Rosengarten 10
D-22880 Wedel

Tel.: +49 - 41 03 - 9 37 76 10
Fax: +49 - 41 03 - 9 37 76 60

www.moeller-wedel-optical.com
e-mail: info@moeller-wedel-optical.com